

3-Phasen Stromschienen Montagezubehör

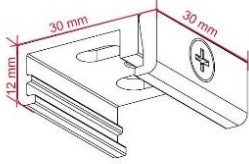

Montagehalterung		
Artikel Nr.	Ausführung	CHF Brutto
XSKB 12-1	Montagehalterung, Alu	3.50
XSKB 12-2	Montagehalterung, schwarz	3.50
XSKB 12-3	Montagehalterung, weiss	3.50

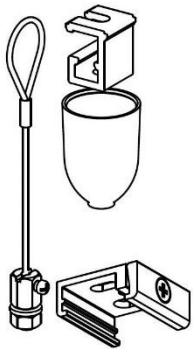

Seilaufhängungs-Set inkl. Montagehalterung		
Artikel Nr.	Ausführung	CHF Brutto
SPW12K-1/1.5	L 1500mm, grau	13.00
SPW12K-2/1.5	L 1500mm, schwarz	13.00
SPW12K-3/1.5	L 1500mm, weiss	13.00
SPW12K-1/3	L 3000mm, grau	14.00
SPW12K-2/3	L 3000mm, schwarz	14.00
SPW12K-3/3	L 3000mm, weiss	14.00
SPW12K-1/5	L 5000mm, grau	15.00
SPW12K-2/5	L 5000mm, schwarz	15.00
SPW12K-3/5	L 5000mm, weiss	15.00

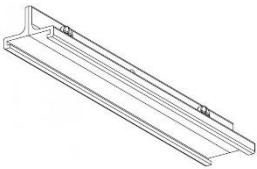

Abhängebrücke		
Artikel Nr.	Ausführung	CHF Brutto
XSKB 18-1	Abhängebrücke, grau	10.30
XSKB 18-2	Abhängebrücke, schwarz	10.30
XSKB 18-3	Abhängebrücke, weiss	10.30



Pendelstange mit Baldachin, inkl. Deckenhalterung		
Artikel Nr.	Ausführung	CHF Brutto
SPR 6-2	Pendelstange, L 1000mm, schwarz	32.80
SPR 6-3	Pendelstange, L 1000mm, weiss	32.80



Pendelaufnahme zu Pendelstange		
Artikel Nr.	Ausführung	CHF Brutto
SP 4R-2	Pendelaufnahme, schwarz	43.60
SP 4R-3	Pendelaufnahme, weiss	43.60

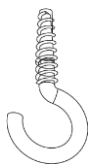

Dekohaken		
Artikel Nr.	Ausführung	CHF Brutto
XTAK 11-1	Dekohaken, Stahl	0.90



Befestigung für Dekohaken		
Artikel Nr.	Ausführung	CHF Brutto
XTAK 14-1	Befestigung für Dekohaken, grau	2.30
XTAK 14-2	Befestigung für Dekohaken, schwarz	2.30
XTAK 14-3	Befestigung für Dekohaken, weiss	2.30

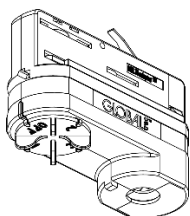

Multi-Adapter 10A 250V, max. Belastung 10 Kg		
Artikel Nr.	Ausführung	CHF Brutto
XTSA 68-1	Multi-Adapter, grau	20.00
XTSA 68-2	Multi-Adapter, schwarz	20.00
XTSA 68-3	Multi-Adapter, weiss	20.00

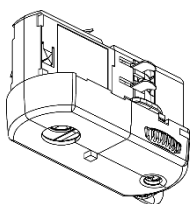

Multi-Adapter 6A 250V, max. Belastung 5 Kg		
Artikel Nr.	Ausführung	CHF Brutto
GA 69-1	Multi-Adapter, grau	20.00
GA 69-2	Multi-Adapter, schwarz	20.00
GA 69-3	Multi-Adapter, weiss	20.00

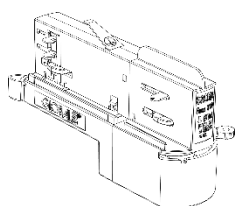

Multiadapter DALI 10A 250V, max. Belastung 10 Kg		
Artikel Nr.	Ausführung	CHF Brutto
GAC 600-1	Multiadapter DALI, grau	32.00
GAC 600-2	Multiadapter DALI, schwarz	32.00
GAC 600-3	Multiadapter DALI, weiss	32.00

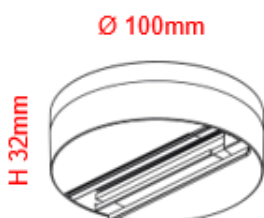

Fixpunkt Decken- und Wandanschluss für Aufbaumontage 10A /250V		
Artikel Nr.	Ausführung	CHF Brutto
GA 70-1	Decken- und Wandauslass, grau	49.00
GA 70-2	Decken- und Wandauslass, schwarz	49.00
GA 70-3	Decken- und Wandauslass, weiss	49.00

passend zu Multiadapter XTSA 69, max. Belastung 5 Kg

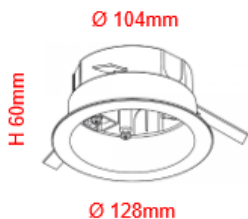

Einbaurahmen für Deckenanschluss, max. Belastung 5 Kg

Artikel Nr.	Ausführung	CHF Brutto
XTSA 71-1	Einbaurahmen, grau	41.00
XTSA 71-2	Einbaurahmen, schwarz	41.00
XTSA 71-3	Einbaurahmen, weiss	41.00

passend zu Fixpunkt GA 70, einstellbar für verschiedene Deckenstärken, max. 30mm

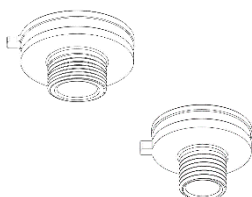

Nippel

Artikel Nr.	Ausführung	CHF Brutto
XTSA 55/12	Rotierender Nippel M 13, Gewinde L 12mm	4.50
XTSA 56/8	Fixer Nippel M 13, Gewinde L 8mm	4.50
XTSA 57/8	Rotierender Nippel M 10, Gewinde L 8mm	4.50
XTSA 57/12	Rotierender Nippel M 10, Gewinde L 12mm	4.50

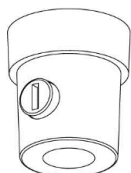

Zugentlaster

Artikel Nr.	Ausführung	CHF Brutto
ZUGENTL10-2	Zugentlaster, Kunststoff M 10, schwarz	2.50
ZUGENTL10-3	Zugentlaster, Kunststoff M 10, weiss	2.50
ZUGENTL10-2	Zugentlaster, Kunststoff M 13, schwarz	2.50
ZUGENTL10-3	Zugentlaster, Kunststoff M 13, weiss	2.50

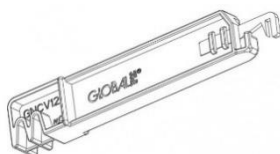

Leiterbiegeschlüssel

Artikel Nr.	Ausführung	CHF Brutto
XTSV 12	Leiterbiegeschlüssel, Stahl/Kunststoff, blau	17.00

Preise exkl. MWST, Preisänderungen vorbehalten

3-Phasen Stromschienen

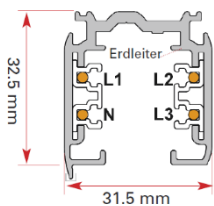
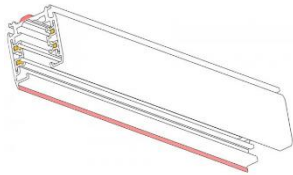

3-Phasen-Aufbau-Stromschienen		
Artikel Nr.	Ausführung	CHF Brutto
XTS 4100-1	L 1000mm, grau	40.00
XTS 4100-2	L 1000mm, schwarz	40.00
XTS 4100-3	L 1000mm, weiss	40.00
XTS 4200-1	L 2000mm, grau	80.00
XTS 4200-2	L 2000mm, schwarz	80.00
XTS 4200-3	L 2000mm, weiss	80.00
XTS 4300-1	L 3000mm, grau	120.00
XTS 4300-2	L 3000mm, schwarz	120.00
XTS 4300-3	L 3000mm, weiss	120.00
XTS 4400-1	L 4000mm, grau	160.00
XTS 4400-2	L 4000mm, schwarz	160.00
XTS 4400-3	L 4000mm, weiss	160.00

3-Phasen-Aufbau-Stromschiene, 16A, 230/240V, Alu, weiss (RAL 9010), schwarz (RAL 9005) oder grau (AW202JR) pulverbeschichtet.

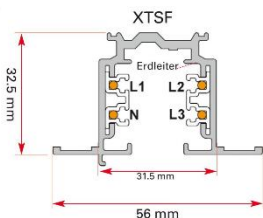
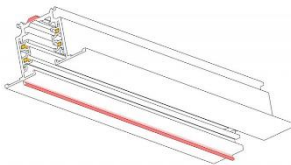

3-Phasen-Einbau-Stromschienen		
Artikel Nr.	Ausführung	CHF Brutto
XTSF 4100-1	L 1000mm, grau	51.00
XTSF 4100-2	L 1000mm, schwarz	51.00
XTSF 4100-3	L 1000mm, weiss	51.00
XTSF 4200-1	L 2000mm, grau	98.00
XTSF 4200-2	L 2000mm, schwarz	98.00
XTSF 4200-3	L 2000mm, weiss	98.00
XTSF 4300-1	L 3000mm, grau	147.00
XTSF 4300-2	L 3000mm, schwarz	147.00
XTSF 4300-3	L 3000mm, weiss	147.00

3-Phasen-Einbau-Stromschiene, 16A, 230/240V, Alu, weiss (RAL 9010), schwarz (RAL 9005) oder grau (AW202JR) pulverbeschichtet.

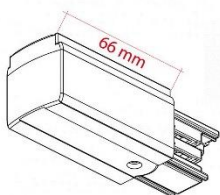

Einspeisung links		
Artikel Nr.	Ausführung	CHF Brutto
XTS 11-1	Einspeisung links, grau	16.40
XTS 11-2	Einspeisung links, schwarz	16.40
XTS 11-3	Einspeisung links, weiss	16.40

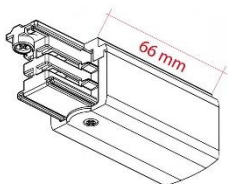

Einspeisung rechts

Artikel Nr.	Ausführung	CHF Brutto
XTS 12-1	Einspeisung rechts, grau	16.00
XTS 12-2	Einspeisung rechts, schwarz	16.00
XTS 12-3	Einspeisung rechts, weiss	16.00

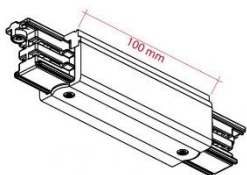

Mitteleinspeisung

Artikel Nr.	Ausführung	CHF Brutto
XTS 14-1	Mitteleinspeisung, grau	47.00
XTS 14-2	Mitteleinspeisung, schwarz	47.00
XTS 14-3	Mitteleinspeisung, weiss	47.00

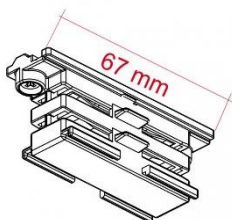

Verbinder

Artikel Nr.	Ausführung	CHF Brutto
XTS 21-1	Verbinder, grau	11.00
XTS 21-2	Verbinder, schwarz	11.00
XTS 21-3	Verbinder, weiss	11.00

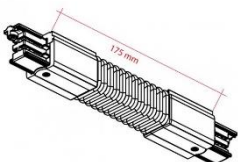

Flexibler Verbinder

Artikel Nr.	Ausführung	CHF Brutto
XTS 23-1	Flexibler Verbinder, grau	49.00
XTS 23-2	Flexibler Verbinder, schwarz	49.00
XTS 23-3	Flexibler Verbinder, weiss	49.00

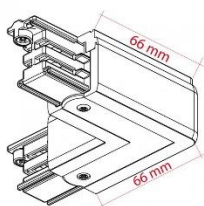

L-Verbinder links, Einspeisung möglich

Artikel Nr.	Ausführung	CHF Brutto
XTS 34-1	L-Verbinder links, grau	36.00
XTS 34-2	L-Verbinder links, schwarz	36.00
XTS 34-3	L-Verbinder links, weiss	36.00

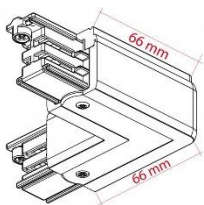

L-Verbinder rechts, Einspeisung möglich

Artikel Nr.	Ausführung	CHF Brutto
XTS 35-1	L-Verbinder rechts, grau	36.00
XTS 35-2	L-Verbinder rechts, schwarz	36.00
XTS 35-3	L-Verbinder rechts, weiss	36.00

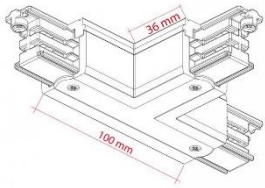

T-Verbinder		
Artikel Nr.	Ausführung	CHF Brutto
XTS 36-1	T-Verbinder, grau	45.00
XTS 36-2	T-Verbinder, schwarz	45.00
XTS 36-3	T-Verbinder, weiss	45.00

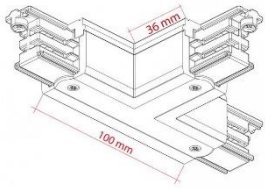

T-Verbinder		
Artikel Nr.	Ausführung	CHF Brutto
XTS 37-1	T-Verbinder, grau	45.00
XTS 37-2	T-Verbinder, schwarz	45.00
XTS 37-3	T-Verbinder, weiss	45.00

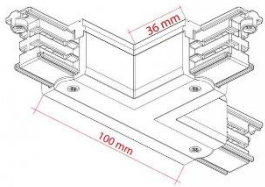

T-Verbinder		
Artikel Nr.	Ausführung	CHF Brutto
XTS 39-1	T-Verbinder, grau	45.00
XTS 39-2	T-Verbinder, schwarz	45.00
XTS 39-3	T-Verbinder, weiss	45.00

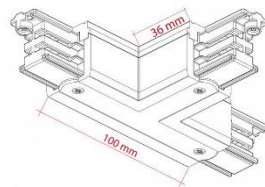

T-Verbinder		
Artikel Nr.	Ausführung	CHF Brutto
XTS 40-1	T-Verbinder, grau	45.00
XTS 40-2	T-Verbinder, schwarz	45.00
XTS 40-3	T-Verbinder, weiss	45.00

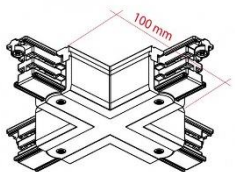

Kreuz-Verbinder		
Artikel Nr.	Ausführung	CHF Brutto
XTS 38-1	Kreuz-Verbinder, grau	61.00
XTS 38-2	Kreuz-Verbinder, schwarz	61.00
XTS 38-3	Kreuz-Verbinder, weiss	61.00

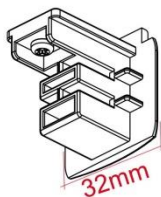

Endkappe		
Artikel Nr.	Ausführung	CHF Brutto
XTS 41-1	Endkappe, grau	2.40
XTS 41-2	Endkappe, schwarz	2.40
XTS 41-3	Endkappe, weiss	2.40

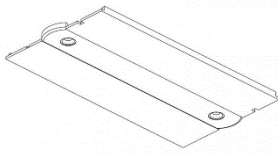

Abdeckplatte für Einbauschienen

Artikel Nr.	Ausführung	CHF Brutto
XTSF 10-1	für Einspeisung, grau	7.30
XTSF 10-2	für Einspeisung, schwarz	7.30
XTSF 10-3	für Einspeisung, weiss	7.30

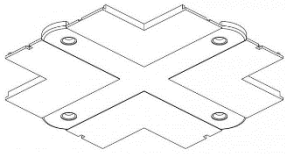

Abdeckplatte für Einbauschienen

Artikel Nr.	Ausführung	CHF Brutto
XTSF 30-1	für L, T und Kreuzverbindung, grau	7.30
XTSF 30-2	für L, T und Kreuzverbindung, schwarz	7.30
XTSF 30-3	für L, T und Kreuzverbindung, weiss	7.30

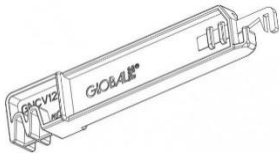

Leiterbiegeschlüssel

Artikel Nr.	Ausführung	CHF Brutto
XTSV 12	Leiterbiegeschlüssel, Stahl/Kunststoff, blau	17.00

Preise exkl. MWST, Preisänderungen vorbehalten

Schneiden der Stromschienen

Schienen werden in Standardlängen geliefert. Diese können jedoch auf jede gewünschte Länge zugeschnitten werden. Danach müssen die Leiter mit dem Biegeschlüssel XTSV 12 um 90° nach innen gebogen und mit dem Plastikkeil ausgeglichen werden.

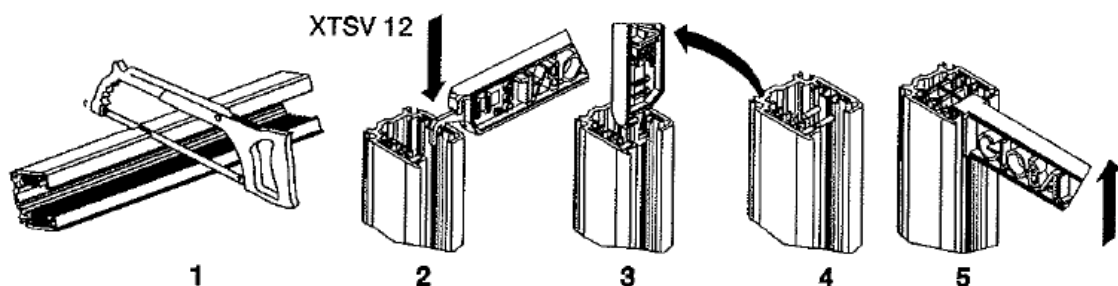

1. Kürzen der Schiene
2. Der Biegewerkzeug wird im Platz gedrückt
3. Biegung
4. Die Leitern sind gebogen
5. Prüfung

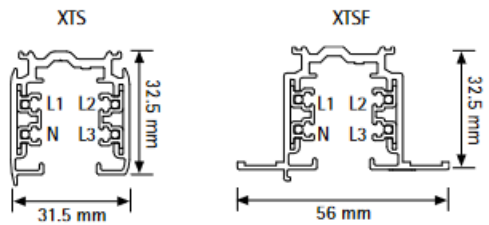
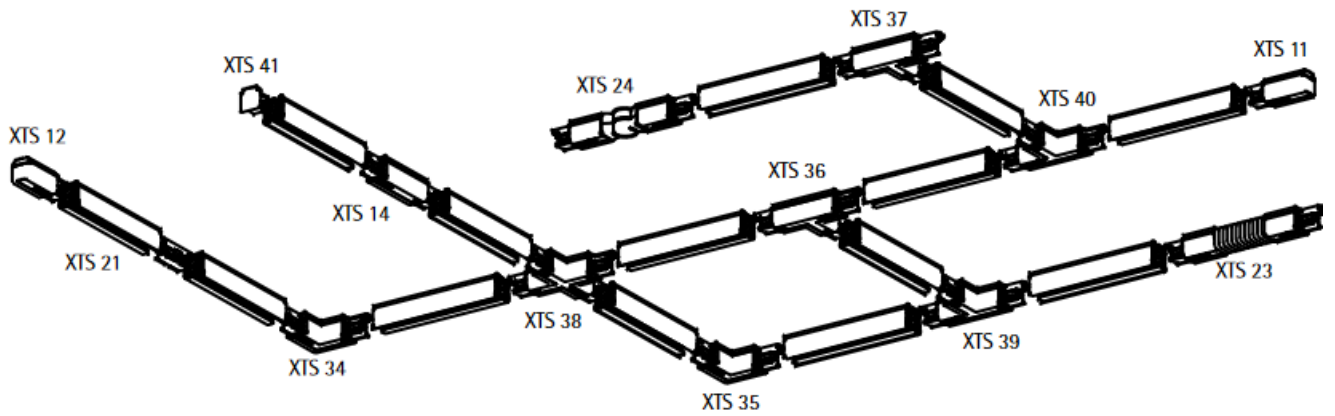

The recommended fastening distance is 1000 mm.
 NOTE: A load not heavier than 10 kg may hang on a power takeoff adapter, the pull strength being 100 N (1kp – 9.81N) and the maximum torque 2.5 Nm. (GA 69 5 kg/50 N).

L/mm	a/mm	b/mm	c/mm	d/mm
1000	250			
2000	250	1000		
3000	250		1000	1000
4000	250		1500	1000

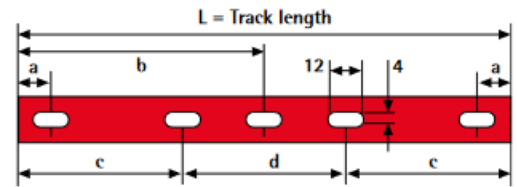
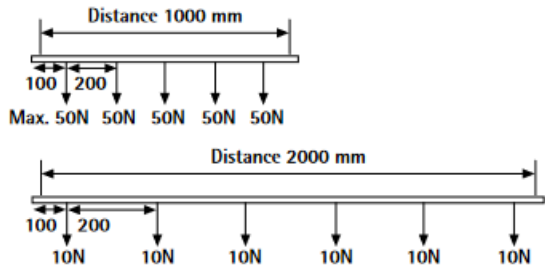

3-Phasen Stromschienen DALI

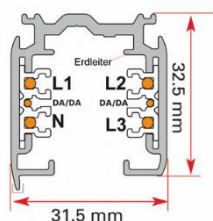
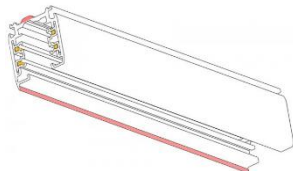

3-Phasen-Aufbau-Stromschienen		
Artikel Nr.	Ausführung	CHF Brutto
XTSC 6100-1	L 1000mm, grau	53.00
XTSC 6100-2	L 1000mm, schwarz	53.00
XTSC 6100-3	L 1000mm, weiss	53.00
XTSC 6200-1	L 2000mm, grau	95.00
XTSC 6200-2	L 2000mm, schwarz	95.00
XTSC 6200-3	L 2000mm, weiss	95.00
XTSC 6300-1	L 3000mm, grau	133.00
XTSC 6300-2	L 3000mm, schwarz	133.00
XTSC 6300-3	L 3000mm, weiss	133.00
XTSC 6400-1	L 4000mm, grau	177.00
XTSC 6400-2	L 4000mm, schwarz	177.00
XTSC 6400-3	L 4000mm, weiss	177.00

3-Phasen-Aufbau-Stromschiene, 16A, 230/240V, Alu, weiss (RAL 9010), schwarz (RAL 9005) oder grau (AW202JR) pulverbeschichtet.

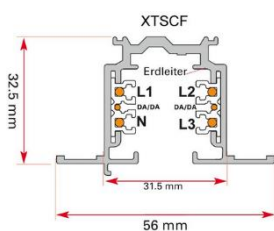
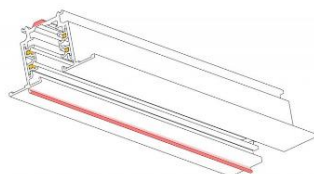

3-Phasen-Einbau-Stromschienen		
Artikel Nr.	Ausführung	CHF Brutto
XTSCF 6100-1	L 1000mm, grau	60.00
XTSCF 6100-2	L 1000mm, schwarz	60.00
XTSCF 6100-3	L 1000mm, weiss	60.00
XTSCF 6200-1	L 2000mm, grau	108.00
XTSCF 6200-2	L 2000mm, schwarz	108.00
XTSCF 6200-3	L 2000mm, weiss	108.00
XTSCF 6300-1	L 3000mm, grau	153.00
XTSCF 6300-2	L 3000mm, schwarz	153.00
XTSCF 6300-3	L 3000mm, weiss	153.00

3-Phasen-Einbau-Stromschiene, 16A, 230/240V, Alu, weiss (RAL 9010), schwarz (RAL 9005) oder grau (AW202JR) pulverbeschichtet.

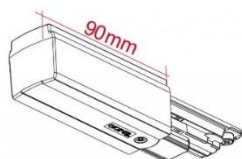

Einspeisung links		
Artikel Nr.	Ausführung	CHF Brutto
XTSC 611-1	Einspeisung links, grau	26.70
XTSC 611-2	Einspeisung links, schwarz	26.70
XTSC 611-3	Einspeisung links, weiss	26.70

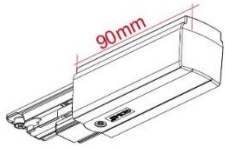

Einspeisung rechts

Artikel Nr.	Ausführung	CHF Brutto
XTSC 612-1	Einspeisung rechts, grau	26.70
XTSC 612-2	Einspeisung rechts, schwarz	26.70
XTSC 612-3	Einspeisung rechts, weiss	26.70

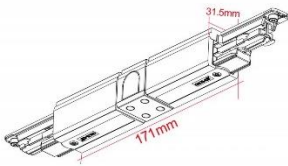

Mittleinspeisung

Artikel Nr.	Ausführung	CHF Brutto
XTSC 614-1	Mittleinspeisung, grau	61.00
XTSC 614-2	Mittleinspeisung, schwarz	61.00
XTSC 614-3	Mittleinspeisung, weiss	61.00

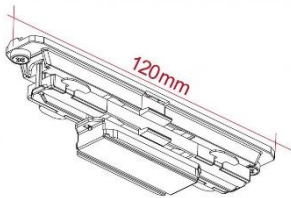

Verbinder

Artikel Nr.	Ausführung	CHF Brutto
XTSC 621-1	Verbinder, grau	18.00
XTSC 621-2	Verbinder, schwarz	18.00
XTSC 621-3	Verbinder, weiss	18.00

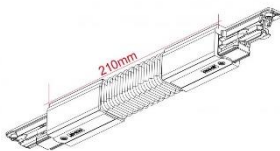

Flexibler Verbinder

Artikel Nr.	Ausführung	CHF Brutto
XTSC 623-1	Flexibler Verbinder, grau	95.00
XTSC 623-2	Flexibler Verbinder, schwarz	95.00
XTSC 623-3	Flexibler Verbinder, weiss	95.00

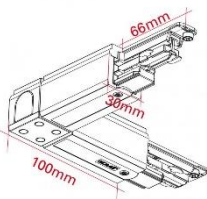

L-Verbinder links, Einspeisung möglich

Artikel Nr.	Ausführung	CHF Brutto
XTSC 634-1	L-Verbinder links, grau	62.00
XTSC 634-2	L-Verbinder links, schwarz	62.00
XTSC 634-3	L-Verbinder links, weiss	62.00

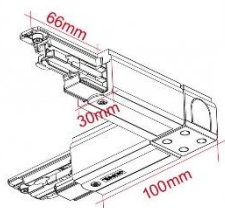

L-Verbinder rechts, Einspeisung möglich

Artikel Nr.	Ausführung	CHF Brutto
XTSC 635-1	L-Verbinder rechts, grau	62.00
XTSC 635-2	L-Verbinder rechts, schwarz	62.00
XTSC 635-3	L-Verbinder rechts, weiss	62.00

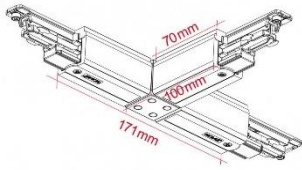

T-Verbinder		
Artikel Nr.	Ausführung	CHF Brutto
XTSC 636-1	T-Verbinder, grau	95.00
XTSC 636-2	T-Verbinder, schwarz	95.00
XTSC 636-3	T-Verbinder, weiss	95.00

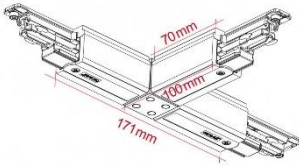

T-Verbinder		
Artikel Nr.	Ausführung	CHF Brutto
XTSC 637-1	T-Verbinder, grau	95.00
XTSC 637-2	T-Verbinder, schwarz	95.00
XTSC 637-3	T-Verbinder, weiss	95.00

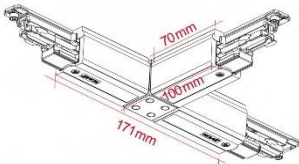

T-Verbinder		
Artikel Nr.	Ausführung	CHF Brutto
XTSC 639-1	T-Verbinder, grau	95.00
XTSC 639-2	T-Verbinder, schwarz	95.00
XTSC 639-3	T-Verbinder, weiss	95.00

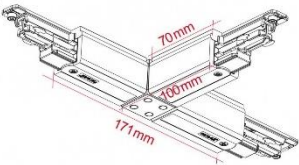

T-Verbinder,		
Artikel Nr.	Ausführung	CHF Brutto
XTSC 640-1	T-Verbinder, grau	95.00
XTSC 640-2	T-Verbinder, schwarz	95.00
XTSC 640-3	T-Verbinder, weiss	95.00

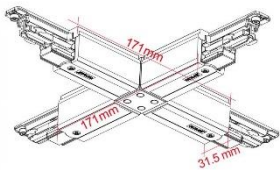

Kreuz-Verbinder		
Artikel Nr.	Ausführung	CHF Brutto
XTSC 638-1	Kreuz-Verbinder, grau	133.00
XTSC 638-2	Kreuz-Verbinder, schwarz	133.00
XTSC 638-3	Kreuz-Verbinder, weiss	133.00



Endkappe		
Artikel Nr.	Ausführung	CHF Brutto
XTS 41-1	Endkappe, grau	2.40
XTS 41-2	Endkappe, schwarz	2.40
XTS 41-3	Endkappe, weiss	2.40

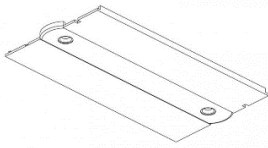

Abdeckplatte für Einbauschienen		
Artikel Nr.	Ausführung	CHF Brutto
XTSF 610-1	für Einspeisung, grau	7.30
XTSF 610-2	für Einspeisung, schwarz	7.30
XTSF 610-3	für Einspeisung, weiss	7.30

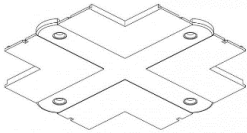

Abdeckplatte für Einbauschienen		
Artikel Nr.	Ausführung	CHF Brutto
XTSF 630-1	für L, T und Kreuz-Verbindung, grau	7.30
XTSF 630-2	für L, T und Kreuz-Verbindung, schwarz	7.30
XTSF 630-3	für L, T und Kreuz-Verbindung, weiss	7.30

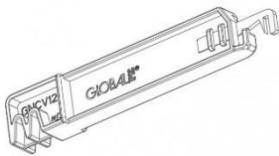

Leiterbiegeschlüssel		
Artikel Nr.	Ausführung	CHF Brutto
XTSV 12	Leiterbiegeschlüssel, Stahl/Kunststoff, blau	17.00

Preise exkl. MWST, Preisänderungen vorbehalten

Schneiden der Stromschiene

Schiene werden in Standardlängen geliefert. Diese können jedoch auf jede gewünschte Länge zugeschnitten werden. Danach müssen die Leiter mit dem Biegeschlüssel XTSV 12 um 90° nach innen gebogen und mit dem Plastikteil ausgeglichen werden.

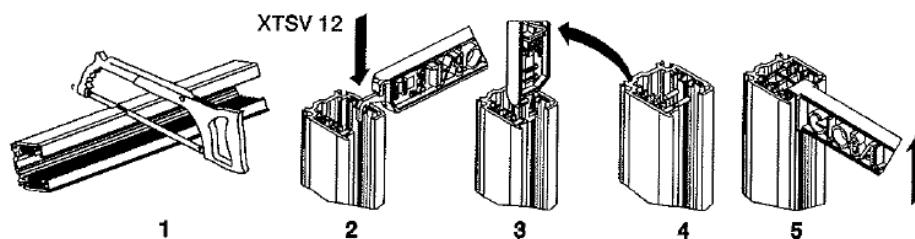

1. Kürzen der Schiene
2. Der Biegewerkzeug wird im Platz gedrückt
3. Biegung
4. Die Leitern sind gebogen
5. Prüfung

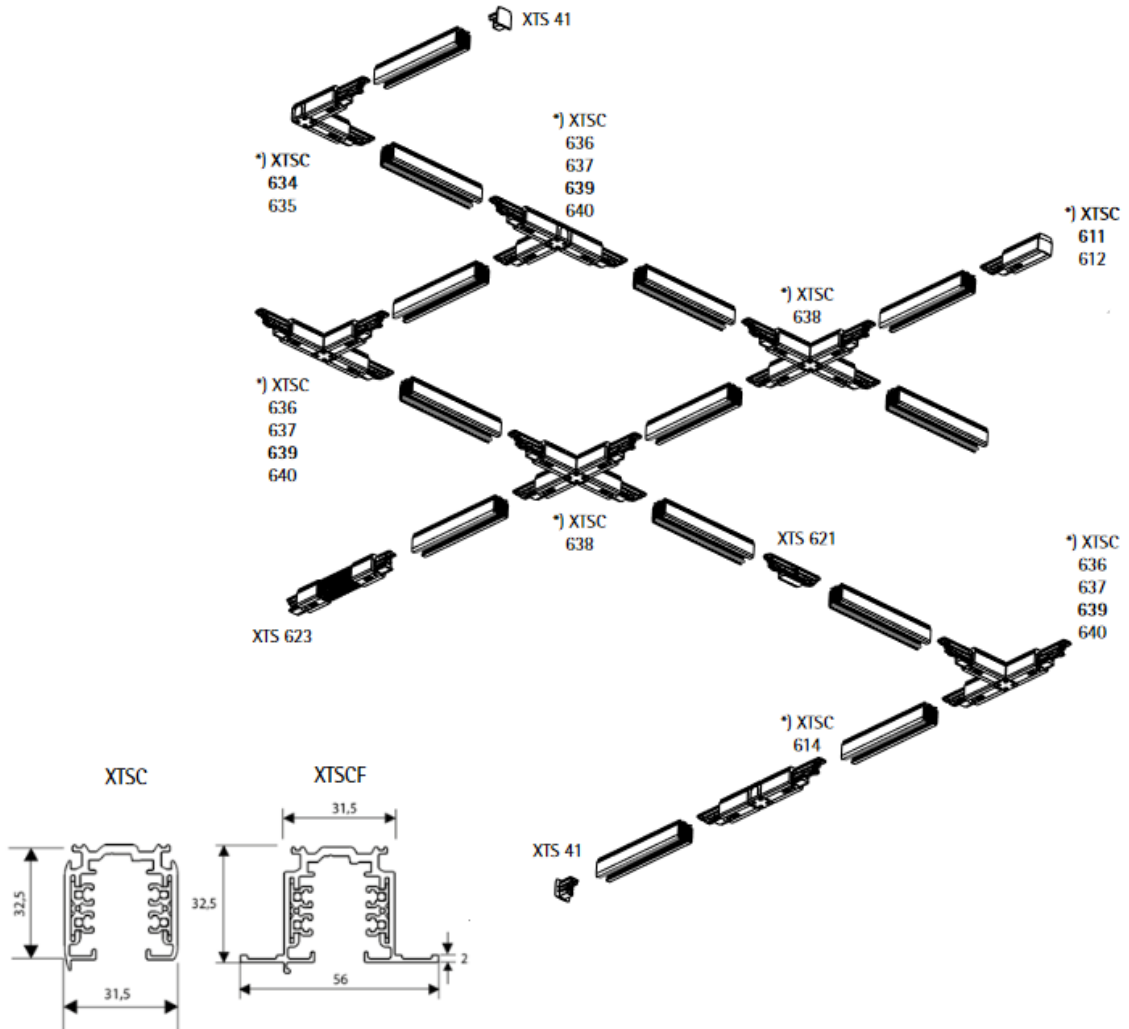

The recommended fastening distance is 1000 mm.
 NOTE: A load not heavier than 10 kg may hang on a power takeoff adapter, the pull strength being 100 N (1kp = 9.81N) and the maximum torque 2.5 Nm. (GA 69 5 kg/50 N).

L/mm	a/mm	b/mm	c/mm	d/mm
1000	250			
2000	250	1000		
3000	250		1000	1000
4000	250		1500	1000

